

MPF PRODUCTS INC.

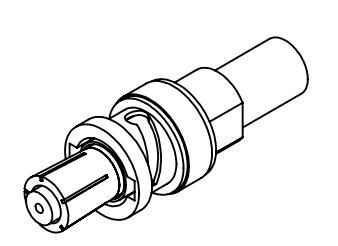
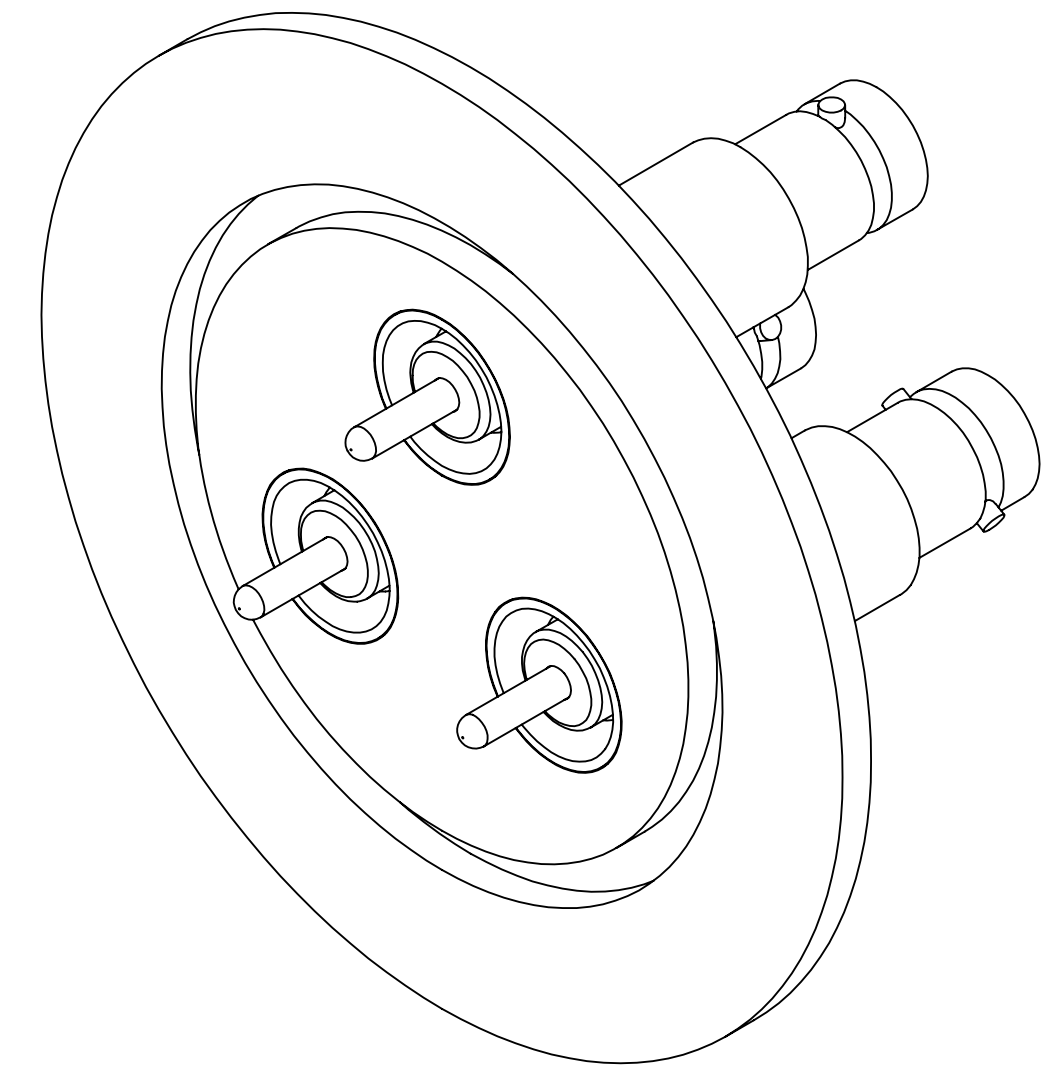
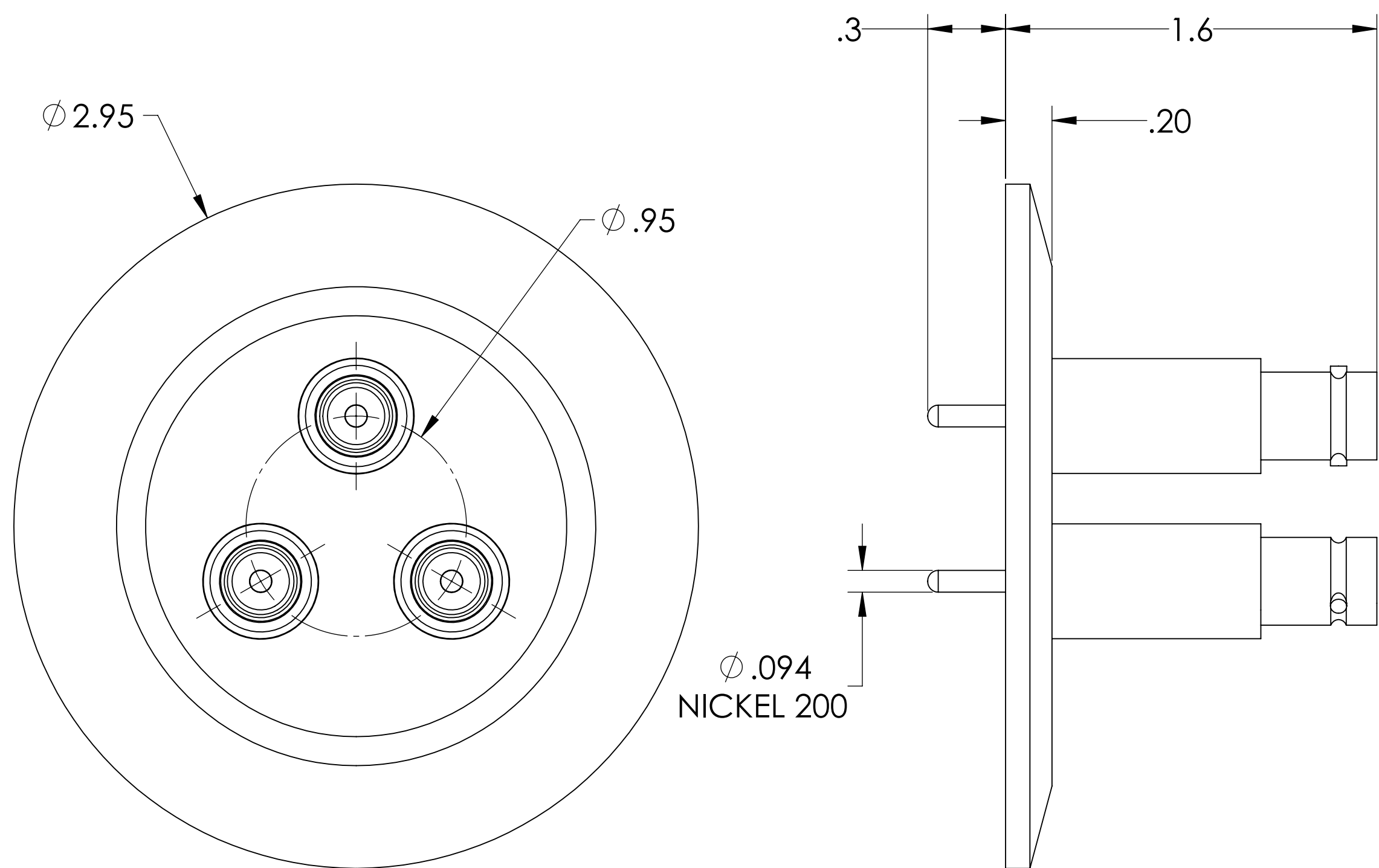

PART #	AIRSIDE CONNECTOR INCLUDED
A0343-1-QF	YES
A0343-2-QF	NO

NOTE:

1. SHIELD: GROUNDED
2. VOLTAGE: 5000 VOLTS DC
3. CURRENT: 5 AMPS
4. TEMPERATURE RATING: -200 TO 450°C (FEEDTHROUGH), 65 TO 165°C (AIRSIDE CONNECTOR)
5. IMPEDANCE: NON-CONSTANT

SHV-5 Coaxial Feedthrough, 3 Pins, Grounded Shield, 2.95" QF/KF, UHV Compatible

UNLESS OTHERWISE SPECIFIED:	QUOTATION #	N/A					
DIMENSIONS ARE IN INCHES TOLERANCES:	DRAWN	NAME	DATE				
ANGULAR: MACH ± 1/2°	WJ	WJ	9/11/2015				
TWO PLACE DECIMAL ± .030	CHECKED		9/11/2015				
THREE PLACE DECIMAL ± .015	ENG APPR.	WJ	9/11/2015				
MATERIAL	THIRD ANGLE:						
FINISH	APPLICATION	<table border="1"> <tr> <th>NEXT ASSY</th> <th>USED ON</th> </tr> <tr> <td> </td> <td> </td> </tr> </table>		NEXT ASSY	USED ON		
NEXT ASSY	USED ON						
PLATING	SURFACE FINISH:	63 OR BETTER					
	UNLESS OTHERWISE SPECIFIED:	ALL DIAMETERS CONCENTRIC WITHIN .005. REMOVE ALL BURRS AND SHARP EDGES					
	TITLE:	SHV-5 COAXIAL FEEDTHROUGH, 3 PINS, GROUNDED SHIELD, 2.95" QF/KF					
	DOWNLOADED FROM MPFPI.COM						
	DWG. NO.	A0343	REV				
	Thursday, January 17, 2019 3:30:38 PM						